

Nastavení propojek

OFF ON

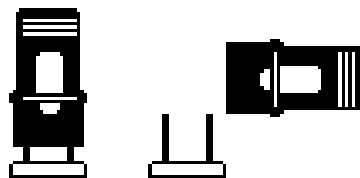

oběhové čerpadlo

JP2

propan G31

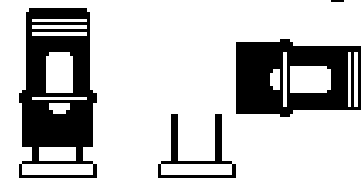

zemní plyn G20

druh plynu

JP1

maximální teplota ohřevu TUV



75°C



+ 5°C set

JP5



kombinovaný kotel



kotel se zásobníkem pro ohřev TUV

JP6

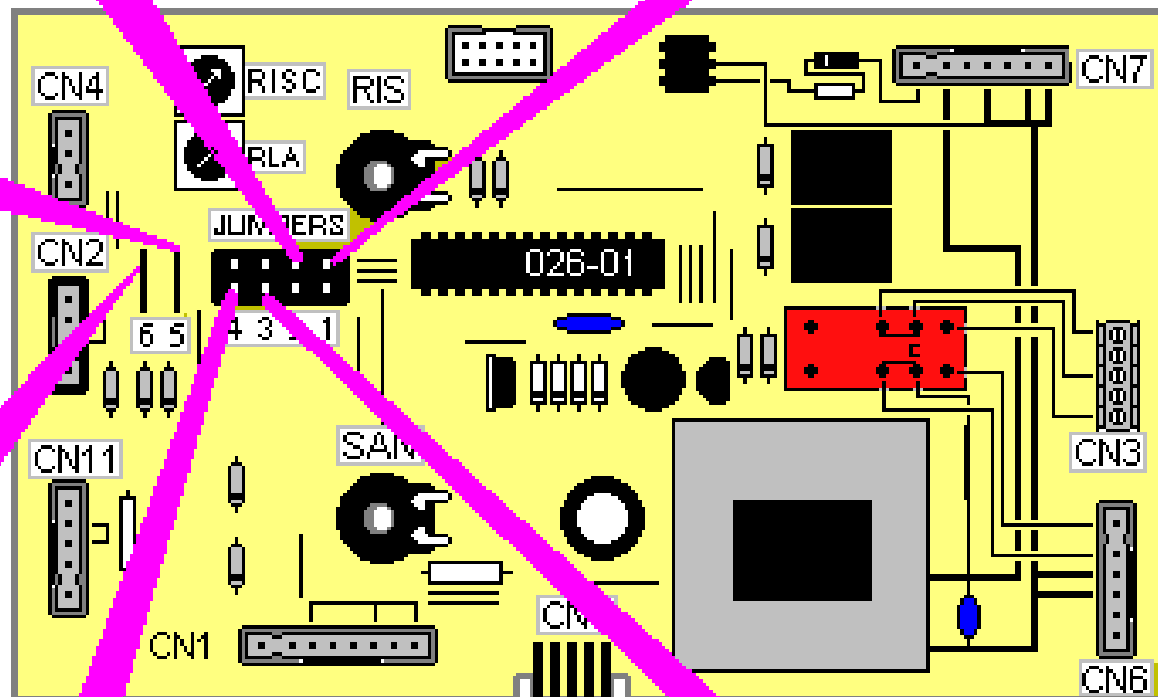

JP4

OFF ON

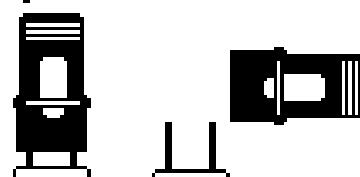

doba prodlení při vynutí NTC čidla = 3 min.

30-40°C

JP3

30-80°C

nastavení teploty topné vody

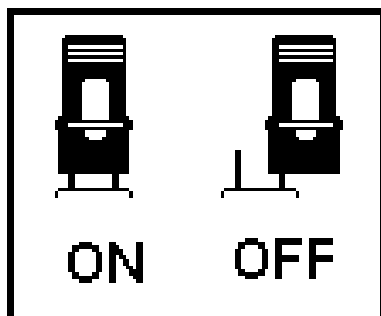
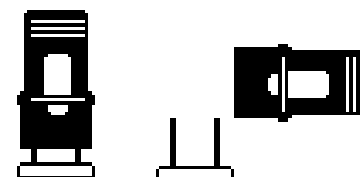

trimer 12V =
zapnut = ON
vypnut = OFF

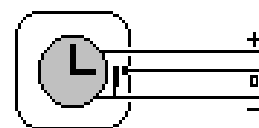
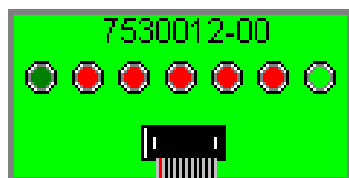

prostor.
termost.

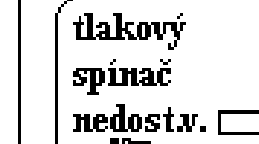

tlakový
spínač
nedost.v.

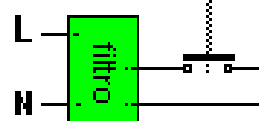

hlavní vypínač

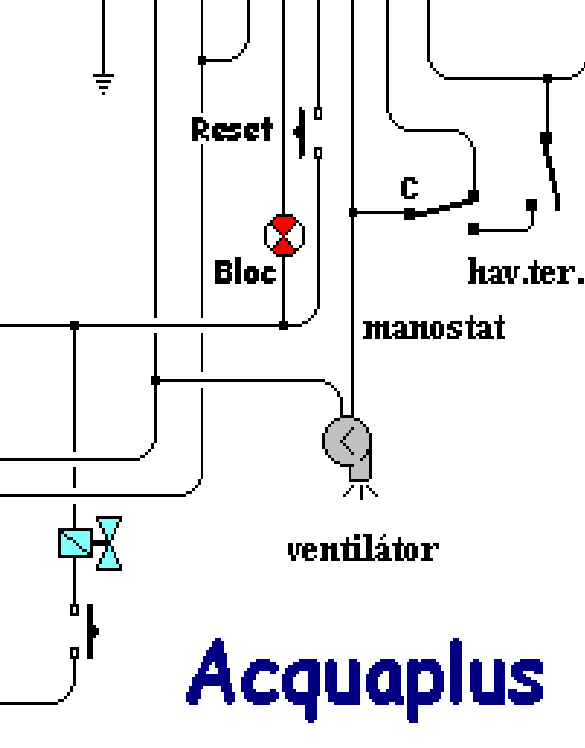
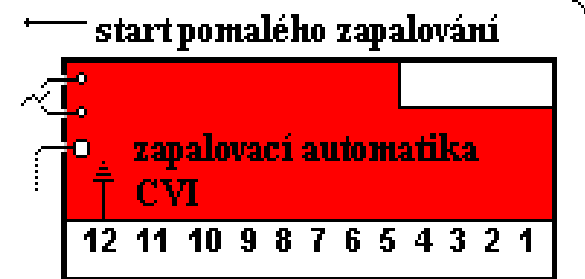
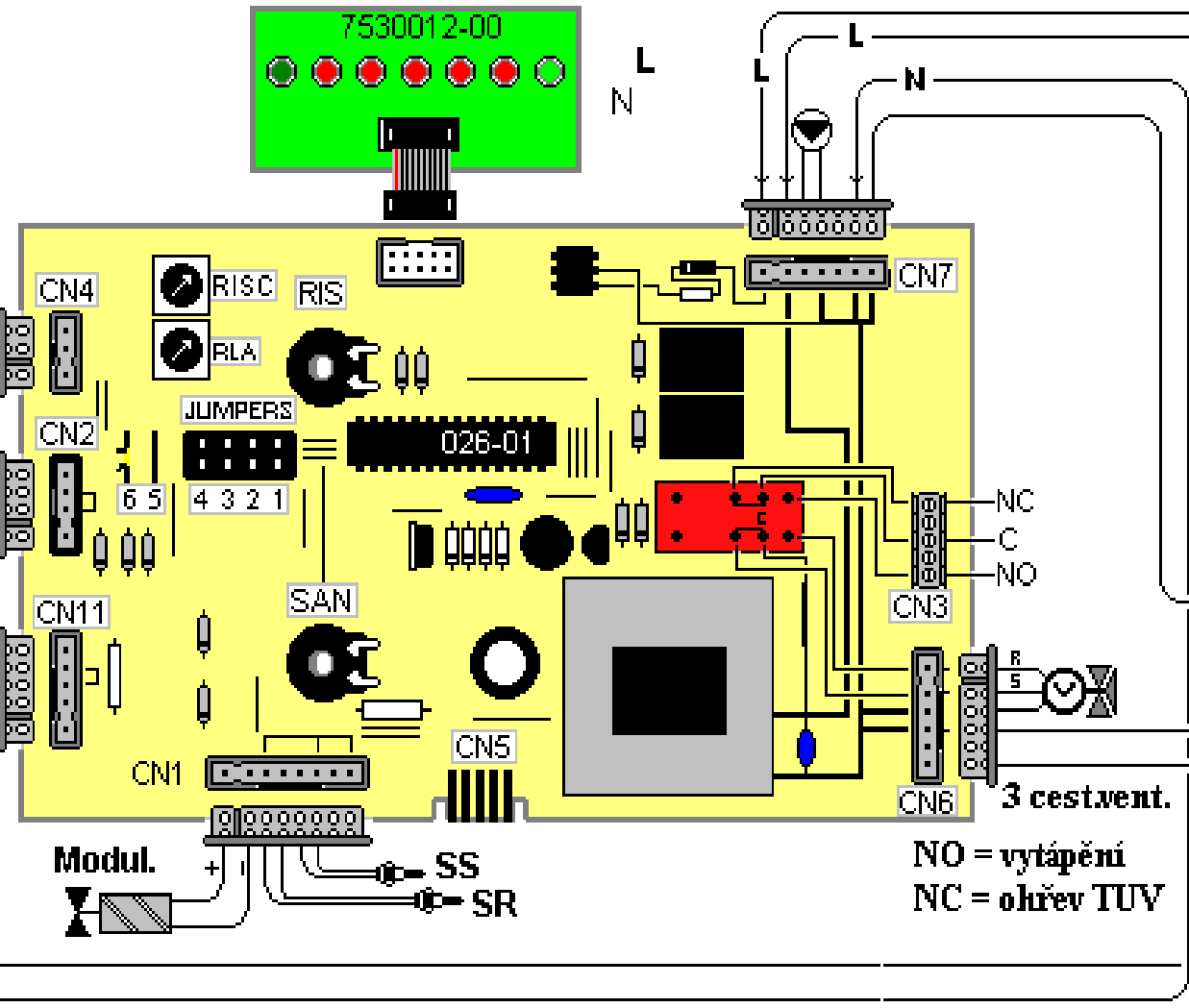

NO = vytápění
NC = ohřev TUV

Acquaplus

ACQUAPLUS

